

Project:	Date
Type:	
Model:	

Features:

- HOUSING MATERIALS** | Extruded aluminum alloy #6063
Powder coating, T=60~80 um.
- FINISH** | Black / Graphite / Silver
- REFLECTOR** | Optical reflector efficiency >85%
- LED** | NICHIA
- DIMMABLE** | No
- OPERATING TEMPERATURE** | -4°F to 104°F
- POWER CABLE** | H05RN-F 3X1.0mm² L=0.3m (High voltage)
- FIXTURE IP/ IK Rating** | IP67 Rated / IK10



RWB



OPTICS



FINISH OPTIONS



Black
RAL9005

Example: RWB-11L30K-D24-Z-BK



Series	Lumens (CCT)			Beam Angle	Voltage	Finish
RWB Wall light 10 Watts	11L30K 11L (3000K) 1,170 Lumens	13L40K 13L (4000K) 1,300 Lumens	13L50K 13L (5000K) 1,335 Lumens	D55 55°	Z Z = 120 Volts	BK Black

Enter configuration: _____

Dimensions and values shown are nominal. LuminosoLED continually works to improve products and reserves the right to make changes which may alter the performance or appearance of products.

PERFORMANCE DATA

Series	RWB-10W
Power	10W
Lumens	1,170 (30K)
IK Testing	IK10
Operating Temp.	-4°F to 104°F
Input	120V

DIMENSIONS

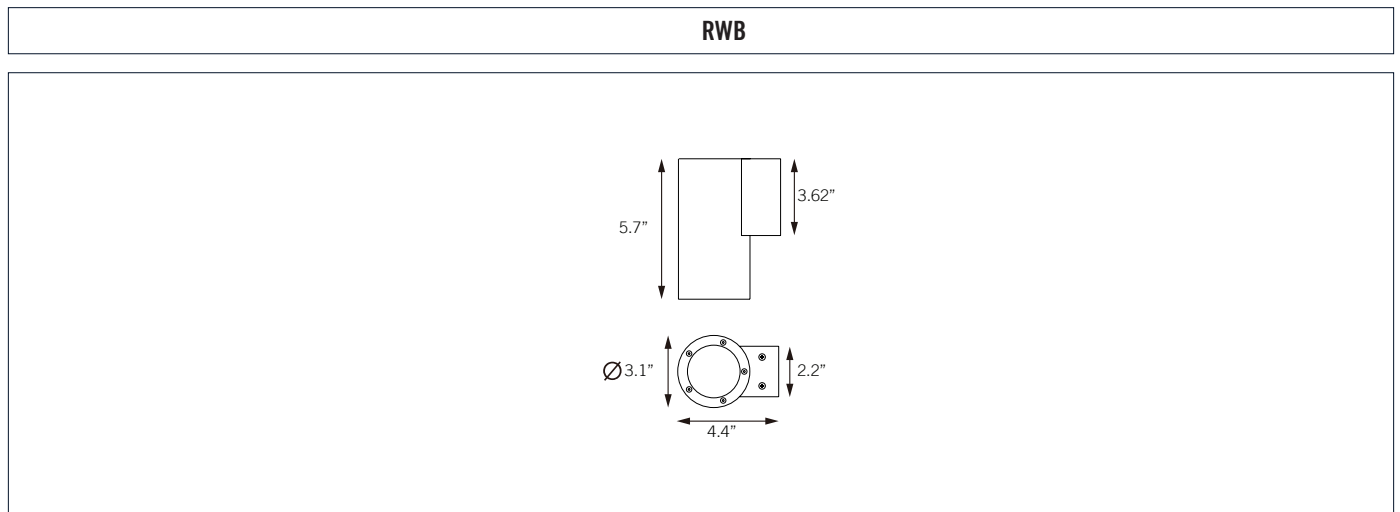

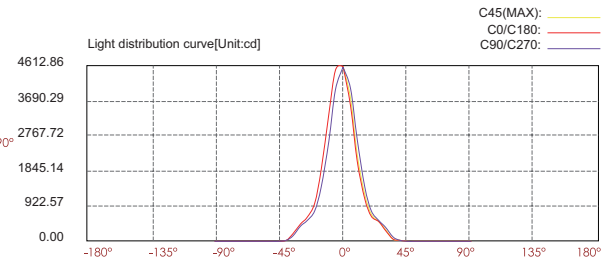
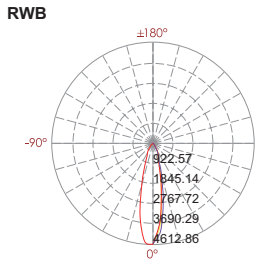
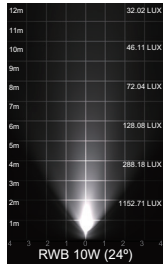

Lux distance cure

Center beam LUX	Beam width	
	V	H
2m 1152.71 LUX	0.8m	0.8m
4m 288.18 LUX	1.6m	1.6m
6m 128.08 LUX	2.4m	2.4m
8m 72.04 LUX	3.2m	3.3m
10m 46.11 LUX	4.0m	4.1m
12m 32.02 LUX	4.9m	4.9m

Ver.Spread:22.9 Horiz.Spread:23.0

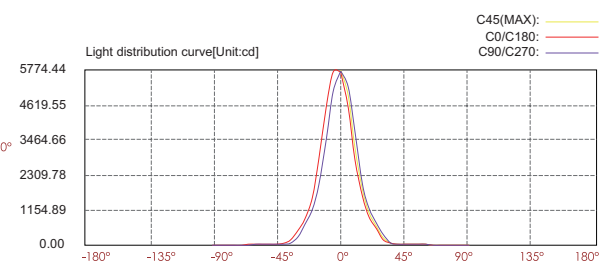
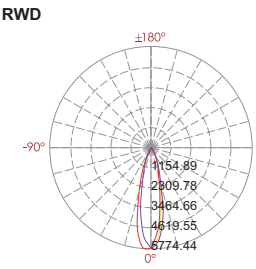
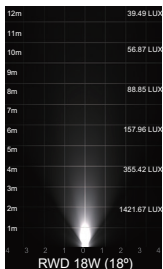

Lux distance cure

Center beam LUX	Beam width	
	V	H
2m 1421.67 LUX	0.9m	0.9m
4m 355.42 LUX	1.8m	1.8m
6m 157.96 LUX	2.6m	2.7m
8m 88.85 LUX	3.5m	3.5m
10m 56.87 LUX	4.4m	4.4m
12m 39.49 LUX	5.3m	5.3m

Ver.Spread:24.8 Horiz.Spread:24.9

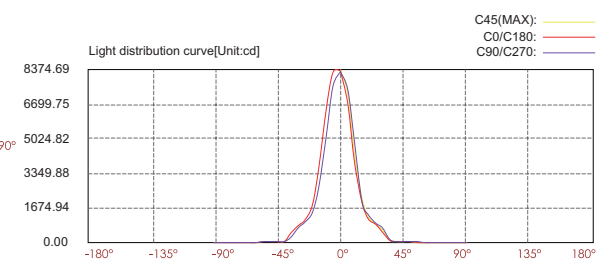
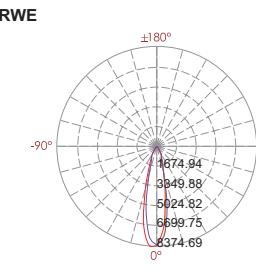
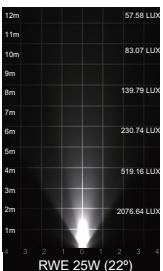

Lux distance cure

Center beam LUX	Beam width	
	V	H
2m 2076.64 LUX	0.9m	0.8m
4m 519.16 LUX	1.7m	1.7m
6m 230.74 LUX	2.6m	2.5m
8m 129.79 LUX	3.4m	3.4m
10m 83.07 LUX	4.3m	4.2m
12m 57.68 LUX	5.1m	5.1m

Ver.Spread:24.2 Horiz.Spread:23.8