

DESCRIPTION

The YPT is engineered for versatile outdoor applications as a dedicated post top luminaire. Featuring selectable color temperature and wattage, it delivers flexible illumination tailored to a variety of project requirements. Constructed with a durable, weather-resistant housing, this fixture is built to withstand harsh outdoor conditions while providing reliable, energy-efficient performance for architectural and site lighting applications.

Project:	Date
Type:	
Model:	

SPECIFICATIONS

Construction:

- Rugged die-cast aluminum construction delivers long-lasting durability and dependable performance in even the most demanding environments.

Optics:

- Selectable Wattage and CCT.
- Type II, Type III, Type IV and Type V.
- External Half Glare shield is available.

Electrical:

- Standard with 0-10V dimming driver(s) from 1% to 100%.
- 120-277VAC / 480VAC (125W Only) 50/60Hz.
- THD: ≤20%
- Designed to withstand surges of up to L/N-PE:10kV
- 3.3ft (39.4") long power cord provided for easier installation.

Controls:

- Photocell and Motion Sensor optional.

Ambient Temperature:

- Ambient operating temperature -40°F to 113°F.

Lifespan:

- Estimated 50,000-hour LED lifespan based on IES LM-80 results and TM-21 calculations



ORDER INFORMATION

EXAMPLE: YPT-WS63-Y-CCTS-3M-BK



Series	Wattage	Voltage	CCTS	Optics	Photocell	Sensor options	Back-light Shield	Emergency Battery Back-up	Finish
YPT LED Post Top	WS63 63W/53W/33W	Y 120-277V	CCTS 3000K/4000K/5000K	2M	Blank No photocell	Blank No sensor	Blank No shield	Blank No EB	BZ Bronze
				3M	PC with photocell	MS Motion Sensor	HGS Half Glare Shield		
	WS125 125W/105W/76W	HV 480V High Voltage for 125W only.		4M		MSB Motion Sensor w/ Bluetooth		EB Emergency Battery Back-up	BK** Black
				5M					

Enter configuration:

** Contact vendor for lead-time

Dimensions and values shown are nominal. LuminosoLED continually works to improve products and reserves the right to make changes which may alter the performance or appearance of products.

PERFORMANCE DATA

Model	Wattage Selectable	Lumens @Max power	Efficacy	B (Back Light)	BUG Rating* U (Up Light)	G (Glare)	Power Factor	Frequency	Voltage
YTPT	63/53/33W	9,135	145	2	0	2	>0.9	50/60Hz	120-277V
	125/105/76W	18,125	145	3	0	3	>0.9	50/60Hz	120-277V

* @Max Power & Type III

ELECTRICAL DATA

Model Series	Wattage(W)	Current (A) / Input Voltage (V)				
		120	200	240	277	347
YTPT	63	0.58	0.35	0.29	0.25	0.2

EPA *Data: Luminaire & integral mounting arm (0°tilt). Other tenons, arms, brackets or other accessories are not included.

Model	EPA(ft²)						Post Top Mount Single
	Pole Mount Arm for Round or Square Poles						
	Single	2@90	2@18 03	@903	@120	4@90	
YTPT	3.51	3.93	4.23	4.28	4.24	4.28	4.45

PHOTOMETRICS

Luminoso LED provides a comprehensive range of optical systems, catering to diverse site lighting needs. Offering exceptional flexibility, these systems enable precise customization of light distribution patterns to perfectly align with specific site requirements.

Type 2

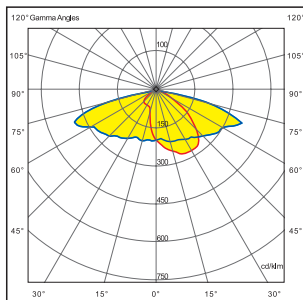

Isoilluminance

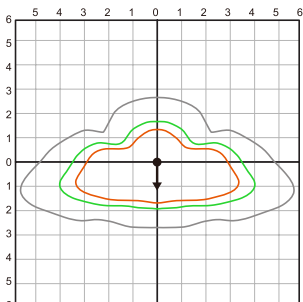

■ 0,1 Fc ■ 0,5 Fc ■ 1 Fc
Isofootcandle plots for the 125W.
Distances are in units of mounting height(15ft)

Type 3

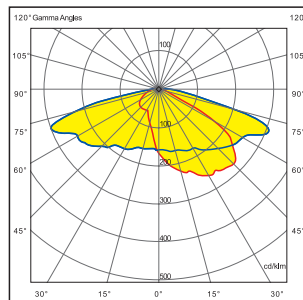

Isoilluminance

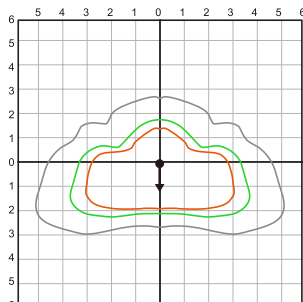

■ 0,1 Fc ■ 0,5 Fc ■ 1 Fc
Isofootcandle plots for the 125W.
Distances are in units of mounting height(15ft)

Type 4

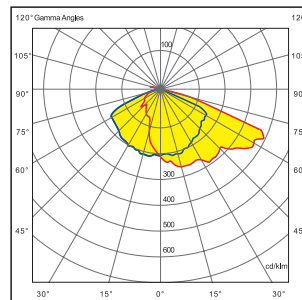

Isoilluminance

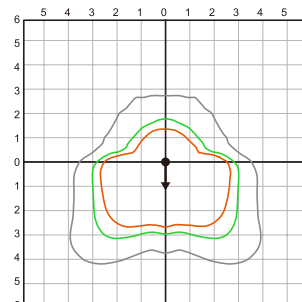

■ 0,1 Fc ■ 0,5 Fc ■ 1 Fc
Isofootcandle plots for the 125W.
Distances are in units of mounting height(15ft)

Type 5 (Standard)

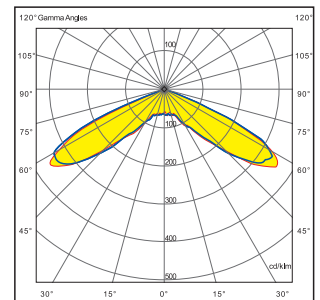

Isoilluminance

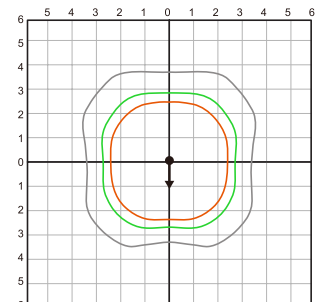

■ 0,1 Fc ■ 0,5 Fc ■ 1 Fc
Isofootcandle plots for the 125W.
Distances are in units of mounting height(15ft)

YPT Post Top

Post top with Selectable Wattage & CCT

DIMENSIONS & WEIGHT

Post Top Mount

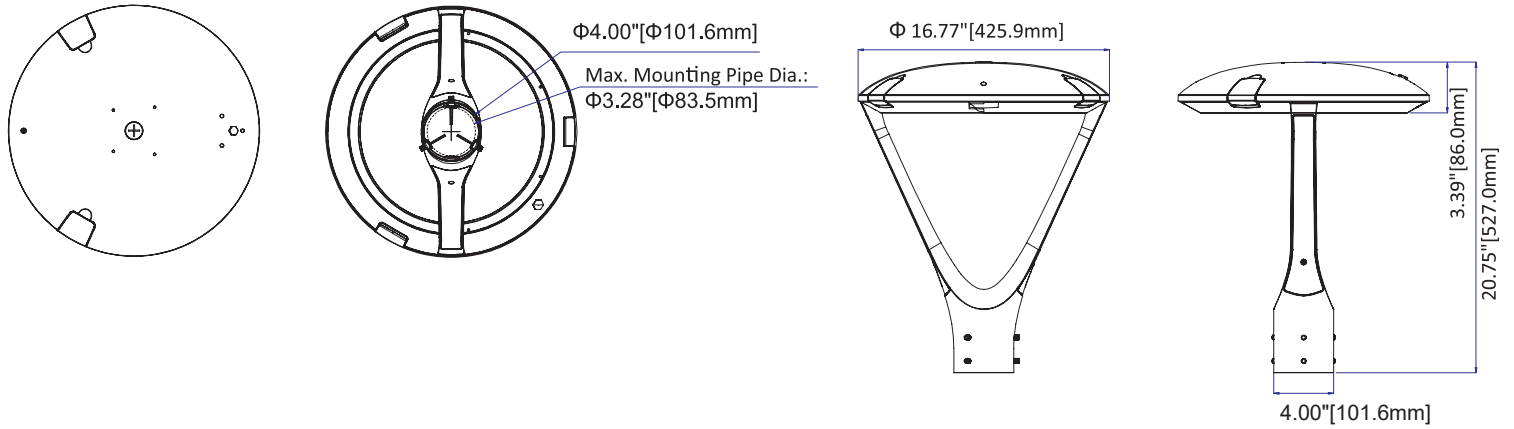

MOUNTING

May be packaged separately

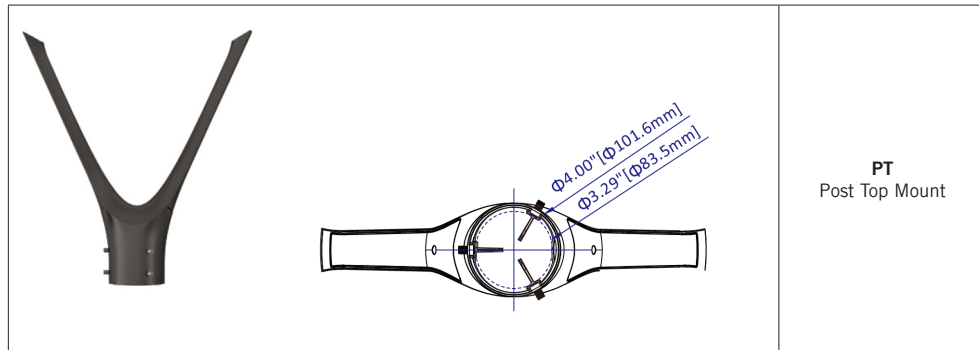

YPT Post Top

Post top with Selectable Wattage & CCT



ACCESSORIES

Control Options (purchase separately)



Sensor Options (purchase separately)

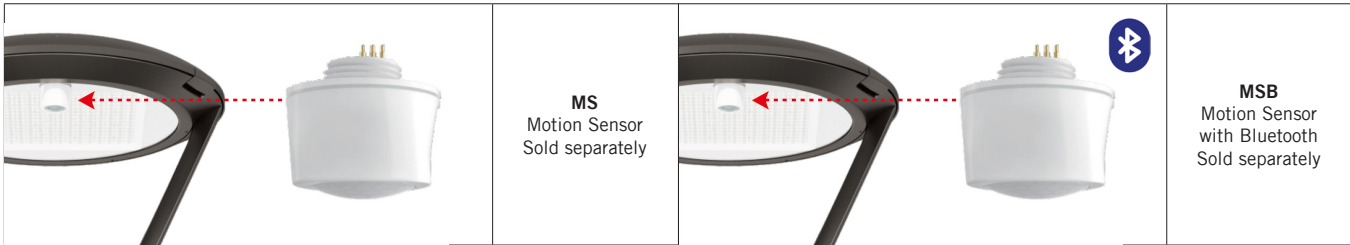

Sensor Options (purchase separately)



Emergency Battery Back-up (Optional)



ACCESSORIES (Glare Control Shield)

Field-installable / Field-Use ONLY (purchase separately)

