

PRODUCT DESCRIPTION

Engineered for versatility, this fixture can be recessed with adjustable hanger bars for different ceiling sizes or surface mounted to suit project needs. Ideal for long corridors and open spaces, it provides up to 1200 lumens for 90 minutes during power outages, fires, or other emergencies. Optional rectangular or oval trim plates ensure a clean fit with any design aesthetic.

KEY FEATURES

- High efficacy 170lm/W, max 1200lm (5000K)
- Provides 90 minutes emergency illumination
- Lens assembly adjustable between 0-15 degree
- Built-in LED indicator and test button
- Recessed and ceiling mounting optional
- Monthly 3 minutes and annual 90 minutes self-test
- Compatible with drywall or drop ceiling mount
- Long-life, maintenance-free Lithium battery
- Meets ETL certification, NFPA 101 Life Safety Code

ACCESSORIES (Trim Plate Optional)



Project:	Date
Type:	
Model:	



ORDER INFORMATION

EXAMPLE: LE-R-DPL-6A-W-L



Series	LED Light	Finish	Battery Type	Trim Plate Accessory
LE-R-DPL Recessed Emergency Light	6A 6x 1watt LED (200Lm each)	W White	L Integrated lithium backup provides 90 minutes of illumination during outages and recharges within 24 hours.	Leave Blank No Trims
LE-S-DPL Surface Emergency Light		B Black**		RTP Rectangular Trim Plate OTP Oval Trim Plate

Enter configuration:

** Contact vendor for leadtime

Dimensions and values shown are nominal. LuminosoLED continually works to improve products and reserves the right to make changes which may alter the performance or appearance of products.

LE S/R DPL 6A W L Series

Emergency LED Light Recessed / Surface



PERFORMANCE DATA

Illumination	<ul style="list-style-type: none"> • Six ultra-bright white LED lamp, energy efficient, have a lifespan of 100,000 hours. • 1.0 watt per LED head, drive of 200 lumen, total 1200lumen. • Each LED optical assembly is adjustable to open at 0-15 degrees.
Battery Backup	<ul style="list-style-type: none"> • The built-in lithium battery backup provides at least 90 minutes of illumination during loss of utility power and will charge within 24 hours of main power restored. • Operational temperature range is 32°F to 122°F. • The battery pack has short circuit, voltage surge, brown out and low battery voltage disconnect protected that improves battery life.
Construction	<ul style="list-style-type: none"> • Fabricated steel housing with hanger bars for drywall or drop ceiling installations. • 5VA flame-retardant, impact-resistant thermoplastic construction. • Optional oval or rectangular trim plates.
Installation	<ul style="list-style-type: none"> • Hanger bars up to 24" are included for mounting within a T-grid ceiling. Conduit entry available at multiple locations from top or sides. Pre-stripped AC input leads provided. Surface and recessed mounting optional.
Self-Test	<ul style="list-style-type: none"> • The integrated Self-Test/Diagnostic circuitry will automatically conducts monthly 3 minutes and annual 90 minutes illumination test, During the testing, the lamp will be trun on to verify proper emergency capability per Life Safety Code requirements.

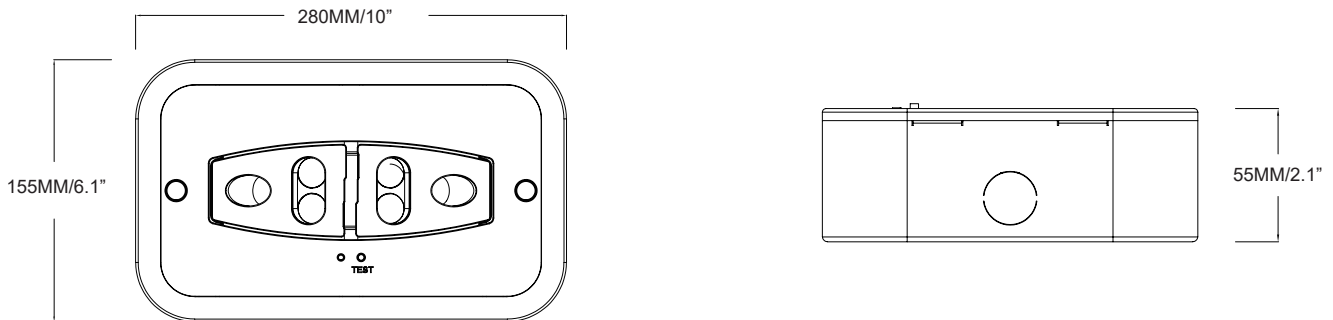

SURFACE MOUNT DIMENSIONS



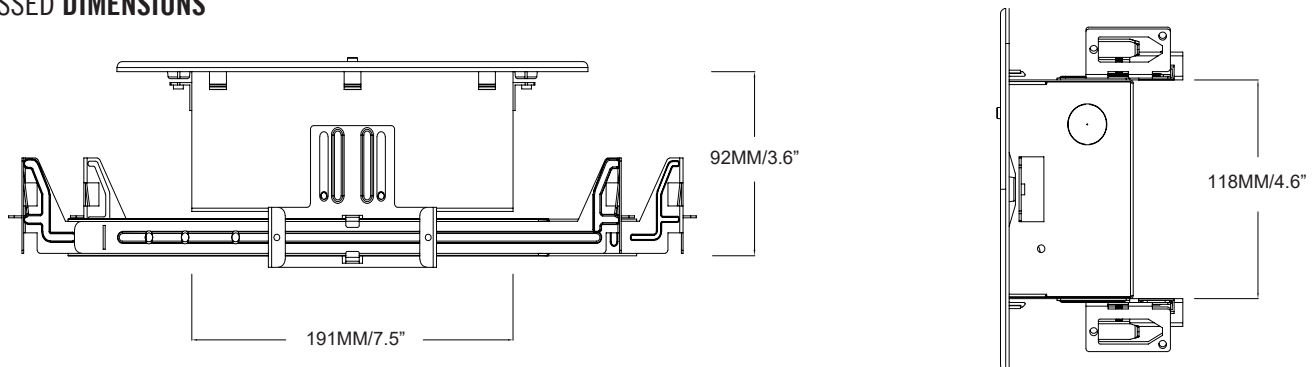



RECESSED DIMENSIONS







ACCESSORIES (Optional)

	<p>RTP</p> 	<p>OTP</p> 
<p>Optional Trim Plates</p>	<p>Rectangle Trim Plate</p>	<p>Oval Trim Plate</p>

TEST BUTTON

TEST Operation		Function
	Press the TEST button once (within 2 secs)	10-second discharge test; FLASHING Green 3 times.
	Press the TEST button twice (within 2 secs)	30-minutes discharge test; FLASHING Green 2 times.
	Press the TEST button three times (within 2 secs)	90-minutes discharge test; FLASHING Green.
 ...	Press once and wait >2S then press again.	Light turned off. Indicator will turn green and back to charging mode.
 ...	Under emergency mode, Long press the test button for >3s	Turn off the light
<p>NOTE: The manual test function needs to connect the battery and plug in the AC power for use.</p>		

INDICATOR

Green Light	Operation	Light Indication
	Slow flashing green light.	Discharging / Emergency mode
	Green light constant ON	Charging battery
	When indicator light is off	The battery is fully charged
	Fast flashing green light	Indicates failure
<p>NOTE: After the fault is cleared, press and hold the test button for 2 seconds. The LED indicator will turn green, indicating the fixture has returned to normal.</p>		

MOUNTING DISTANCE

NFPA 101 sets the fundamental performance standards for emergency lighting systems, requiring an average illumination of 1 foot-candle (10.8 lux) along egress paths, with no point falling below 0.1 foot-candle. These illumination levels must be maintained for a minimum of 90 minutes during a power outage.

SAMPLE PHOTOMETRICS - 3' PATH OF EGRESS

Multiple units mounted at a typical 10' height with a 3' wide path of egress using 80/50/20 reflectances.

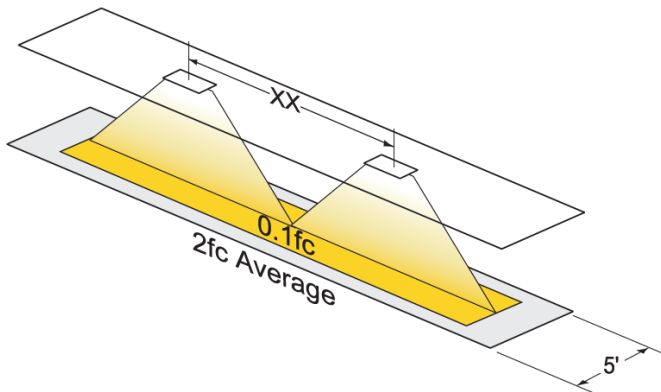

Lamp Adjustment Angle (Per Click)	Fixture Spacing
0°	46'
2°	48'
4°	50'
6°	52'
8°	55'
10°	57'
12°	59'

SAMPLE PHOTOMETRICS - 6' PATH OF EGRESS

Multiple units mounted at a typical 10' height with a 6' wide path of egress using 80/50/20 reflectances.

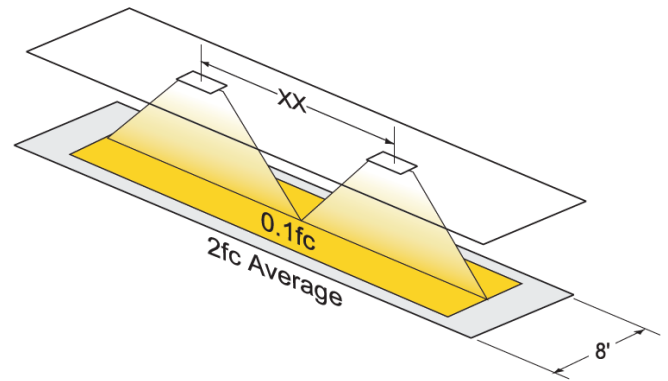

Lamp Adjustment Angle (Per Click)	Fixture Spacing
0°	45'
2°	47'
4°	49'
6°	51'
8°	53'
10°	55'
12°	57'