

DESCRIPTION

Introducing our innovative Modern LED Bollard – setting new standards in outdoor lighting. This bollard features CCT and power selectability, allowing you to fine-tune both color temperature and brightness to suit any setting. Its zonal beam control offers four adjustable light distributions—90°, 180°, 270°, and 360°—giving you the flexibility to direct light precisely where it's needed, whether for pathway guidance or ambient area lighting.

With a sleek design and durable build, these bollards blend effortlessly into any landscape. Smart energy management ensures maximum efficiency, while easy installation and low maintenance make them hassle-free. Versatile for both residential and commercial applications, they redefine outdoor illumination—delivering the perfect balance of style, control, and performance. Illuminate your space with brilliance and precision – experience the future of outdoor lighting.

FEATURES

- Bridgelux 2835 LED
- Corrosion resistant aluminum exterior
- Housing color: Bronze/Black
- IP65 and IK10 rated
- 0-10V dimming
- Light distribution pattern, controlled by DIP switch.
- Incorporated DIP switch for seamless adjustment of 3 CCT options, wattage, and photosensor settings.
- 5 years warranty

Project:	Date
Type:	
Model:	

ADJUSTABLE BEAM DISTRIBUTION



ORDER INFORMATION

EXAMPLE: BLB-Z-WS-Y-CCTS-30-BK



Series	Bollard Style	Wattage Selectable	Voltage	CCTS	EM Battery Back-up	Housing Height	Finish
BLB Bollard	Z (Zone lighting)	WS (24W / 19W / 14W)	Y 120-277V	CCTS Selectable Color Temperature (3000K / 4000K / 5000K) AM** (Amber) 	Blank None EB Emergency Battery Back-up 	Blank Standard 41inch overall height. CHXX Custom Height*	BZ Bronze BK Black

Enter configuration:

** Special Order / Made to order finish

* Custom Height values represent overall fixture height, including bollard head.

Dimensions and values shown are nominal. LuminosoLED continually works to improve products and reserves the right to make changes which may alter the performance or appearance of products.

PERFORMANCE

Model	Wattage Selectable	Lumens	Lm/W	CCT Selectable	Dimming	Power Factor	CRI	Beam	Voltage	Frequency
BLB-Z Modern	24W / 19W / 14W	2,640 2,090 1,540	110lm/W	30K/40K/50K Selectable	0-10V	>0.95	>70	110°	120-277V	50/60Hz

DIMENSIONS

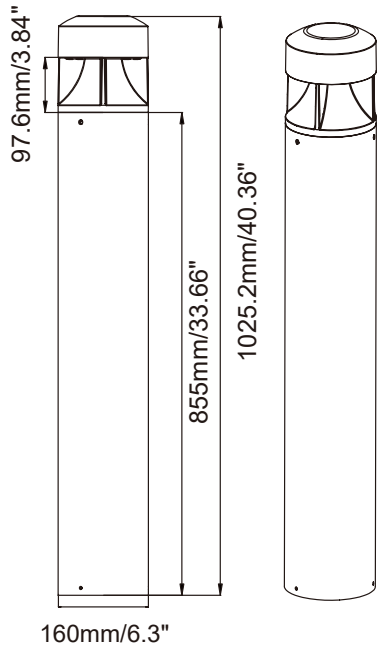

DIP SWITCH ADJUSTS

- Adjustable Beam Distribution
- CCTS
- Wattage
- Photocell
- Emergency Battery Back-up

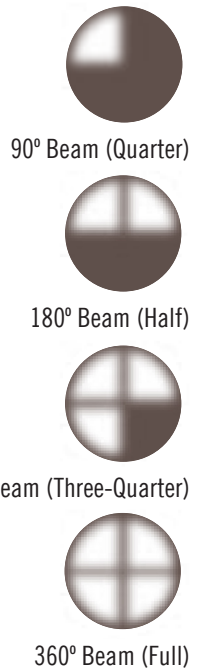
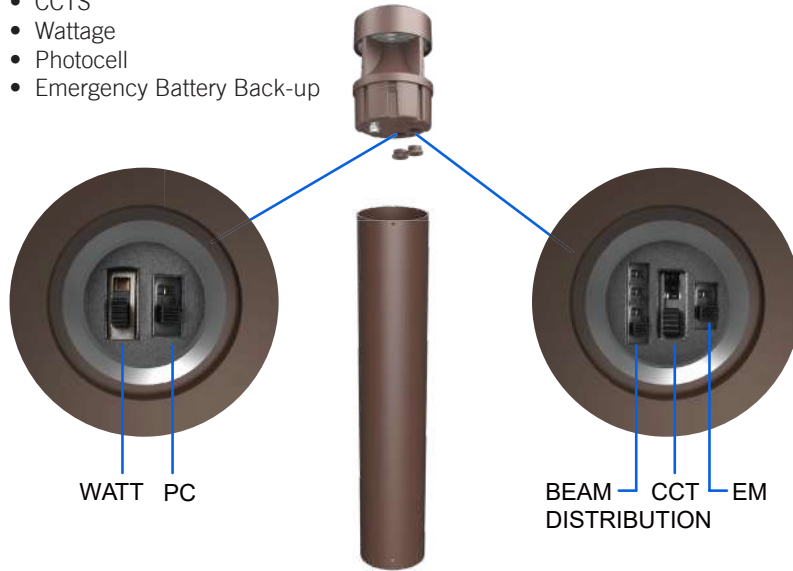

PHOTOMETRIC

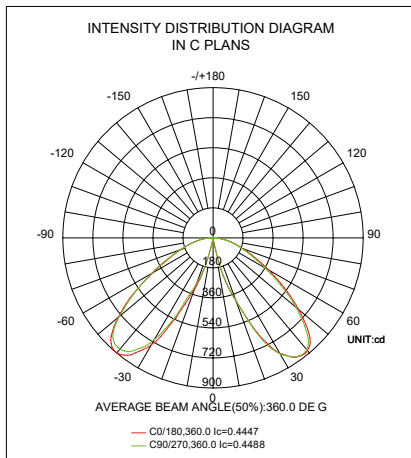

EMERGENCY BATTERY BACK UP



IMPORTANT

CAUTION: Please read these instructions thoroughly before proceeding with the installation of the fixture. Keep this manual for future reference.

Fixtures must be connected in compliance with the National Electrical Code and all relevant local codes. It is essential to ensure proper grounding for safety purposes. The installation of this product must be carried out by a person familiar with both the construction and operation of the product, as well as the associated hazards. Adherence to the applicable installation code is mandatory.

WARNING: Prior to installing or performing maintenance on the fixture, ensure that the power is turned OFF. There are no user-serviceable parts inside.

WARNING: Installation must be conducted on a level surface and above grade.

CAUTION: Utilize a power supply voltage within the range of 120-277V, operating at 50/60 Hz.

Suitable for mounting at a height of 1.2m (4ft) above the ground.

Designed for operation in ambient temperatures not exceeding 55°C.

LOCATION

CAUTION: Prior to installation, ensure the alignment of the Bollard Base is in the orientation that achieves the desired Bollard fixture position.

Designed for wet locations.

1. Mount the Bollard on a stable, level surface.
2. Anchor Bolts can be utilized for new concrete installations.
3. In all other applications, use anchors appropriate for the specific mounting surface.
4. The mounting base must be positioned above grade, with a minimum recommended height of 1-1/2 inches.

ANCHOR BOLT INSTALLATION (Anchor bolt kits included)

CAUTION: Ensure installation is carried out in compliance with all relevant local codes.

Install Anchor Bolts into the concrete foundation (to be performed by others) utilizing the Anchor Bolt Carrier (see Fig. 1) for Round Bollard, or the provided templates (refer to Fig. 7). Alternatively, the Bollard Base can serve as the template. Ensure that Bolt Threads extend approximately 1-1/2 inches from the concrete surface (see Fig. 2).

Fig: 1

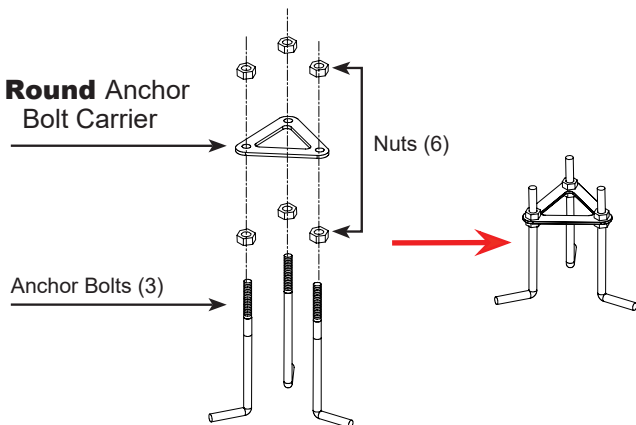
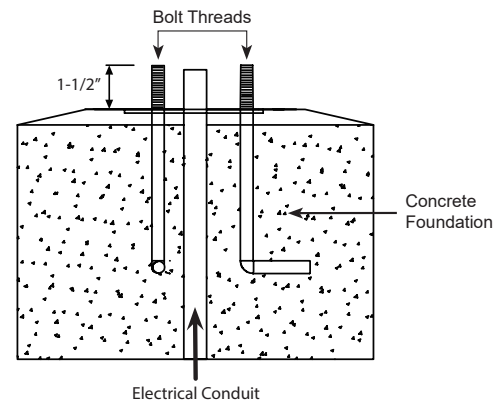

Fig: 2



Round Hardware	
	Anchor Bolt Plate x1
	M10*8 Nut x12
	M10 Spring Washer x3
	M10 Flat Washer x6
	Anchor Bolt x3
	Hex Wrench x1

BOLLARD BASE

1. Remove screws at the bottom of the Housing to separate Bollard Base from Housing (Fig. 3).
2. Position the Bollard Base over the Anchor Bolts (Fig. 4).
3. If leveling is needed, consider adding additional washers (not provided) under the Mounting Base.
4. Secure the Mounting Base to the foundation using the provided hardware (Fig. 5).
5. Ensure that supply leads extend sufficiently for fixture connections. Make wiring connections using Terminal Block or UL-approved connectors.
6. Connect fixture wires to the Terminal Block (see Fig. 5 and Fig. 6).
7. Slide the Housing onto the Bollard Base and secure it with the provided screws (Fig. 7).

Fig: 3

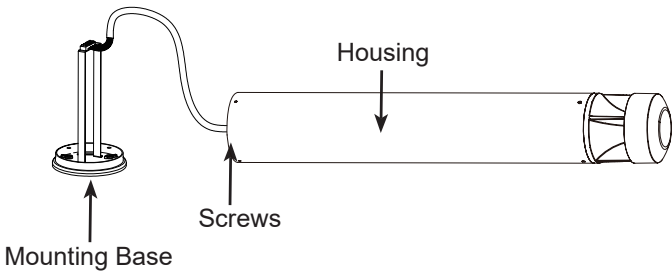

Fig: 4

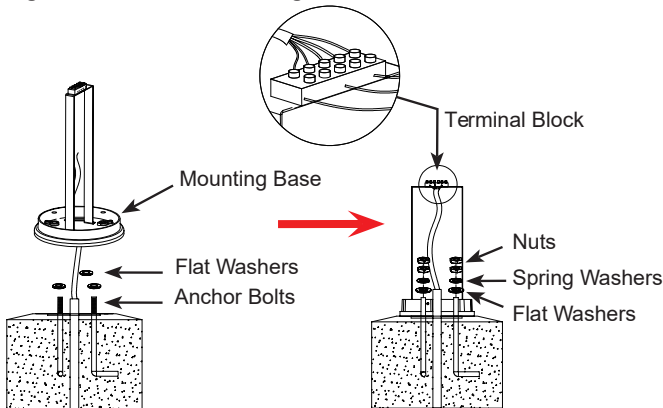

Fig: 5

Fig: 6

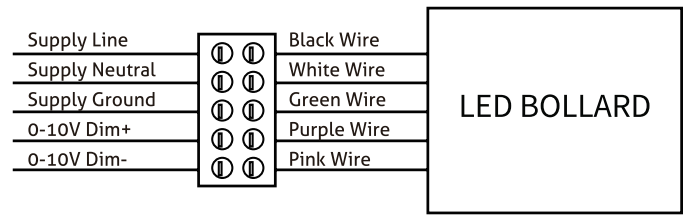
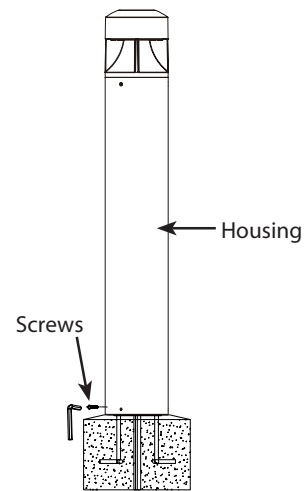
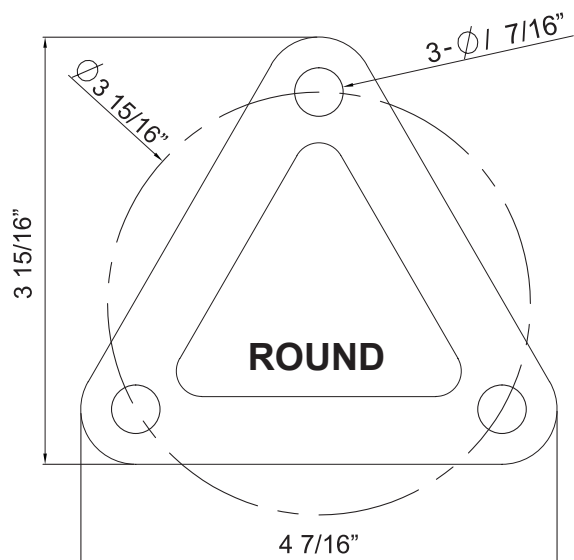

Fig: 7



Anchor Bolt Template (Drawing not to scale)



BLB-Z Bollard

Field Adjustable



BOLLARD BASE

To modify the Fixture Power (W), Color Temperature (CCT), and/or Photocell ON/OFF position from the factory settings, adhere to the instructions below: (CAUTION: Do not switch settings under a load. Ensure power is turned OFF before adjusting the Field Adjustment Switches.)

Factory Default Settings:

Power (W): 24Watts

Color Temperature (CCT): 4000K

Photocell: OFF

1. Unscrew the side screws of the Housing to detach the Bollard Head from the Housing, following the guidance in Fig. 8 for Round Bollard and Fig. 9 for Square Bollard.
2. For Round Bollard, take out the (2) Field Adjust Switch Covers situated beneath the Round Bollard Head. Remove the covers to gain access to the Field Adjust Switches (refer to Fig. 9).
3. Choose the desired Power (W), Color Temperature (CCT), and/or Photocell ON/OFF option by smoothly sliding the corresponding switch to the preferred setting. Refer to Fig. 9. After making adjustments, replace the switch covers.
4. Reattach the Bollard Head to the Housing and secure it in place using the provided screws, as indicated in Fig. 10.

Fig: 9

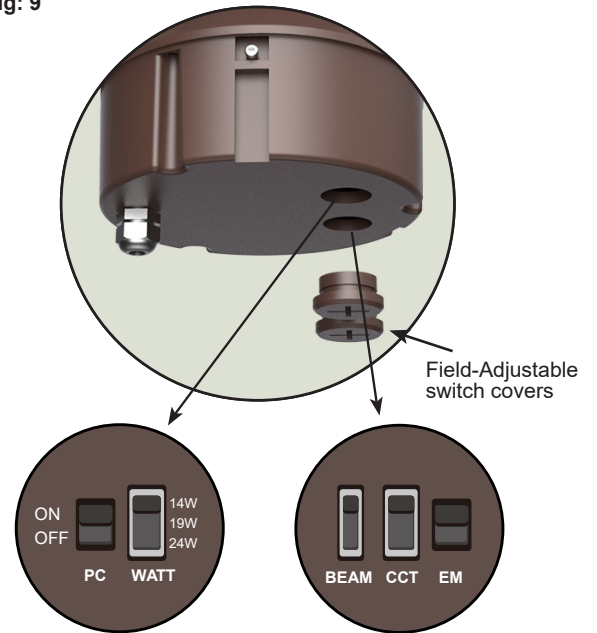

Fig: 8

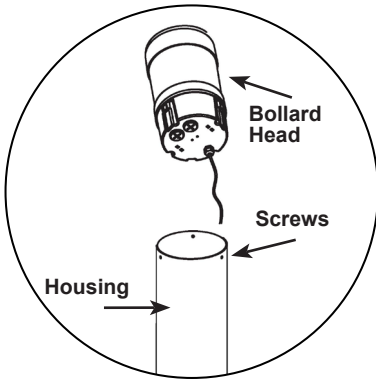

Fig: 10

