

Project:		Date
Type:		
Model#		

## CDE Series LED Downlight Engine

Commercial LED Downlights 6, 7, 8, and 10 inch

### PRODUCT DESCRIPTION

The Luminoso Commercial-grade LED Downlight are suitable for retrofitting non efficient luminaires, and equipped with a fire-rated junction box. The CDE delivers high lumen output while maintaining 80 CRI. With a lifetime greater than 50,000 hours, the Luminoso LED engines are suitable for nearly all commercial applications, providing 3000K, 4000K, and 5000K color temperature options.

### PERFORMANCE SUMMARY

Power: 18W, 27W, 40W, and 54W
Delivered light output: 1,605 - 5,131 lumens
Input voltage: 120-277V
CRI: Ra>80
CCT Options: 3000K, 4000K, 5000K
THD: <20%
PF: >0.9
Standard Warranty: 5 Years
Standard Lifetime: Designed for minimum 50,000 hours
Dimming: Standard 0-10V dimming works with most 5-Wire 0-10V dimmers
The external driver ensures steady performance and long lifespan
Driver efficiency >87%.
Temperature Rating: Designed to operate in -10°F to 113°F

### REGULATORY & VOLUNTARY QUALIFICATIONS

UL Listed  
Energy Star qualified



Series	Wattage	CCT	Options	Reflector	Size (inch)	New Construction Housing
<b>CDE</b>	<b>18W</b>	<b>30K:</b> 3000K	<b>EB</b> Emergency Battery Backup	<b>CDR</b>	<b>6</b>	<b>CDLH-6-N</b>
	<b>27W</b>	<b>40K:</b> 4000K			<b>7</b>	<b>CDLH-7-N</b>
	<b>40W</b>	<b>50K:</b> 5000K			<b>8</b>	<b>CDLH-8-N</b>
	<b>54W</b>				<b>10</b>	<b>CDLH-10-N</b>

Enter configuration:

**EXAMPLE: CDE-27W-40K + CDR-6 + CDLH-6-N**

Series / Performance

Series No.	CDE-18W	CDE-27W	CDE-40W	CDE-54W
Power	18W	27W	40W	54W
Delivered Lumens	1,605 Lm	2,340 Lm	3,345 Lm	5,131 Lm
Efficacy	90 Lm/W	90 Lm/W	90 Lm/W	90 Lm/W
CRI	80	80	80	80
Input	120-277V AC	120-277V AC	120-277V AC	120-277V AC

Photometric:

Fixture photometry has been conducted in accredited testing laboratory in accordance with IESNA LM-79-08.

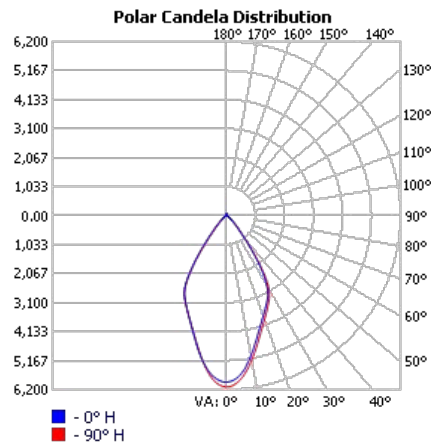
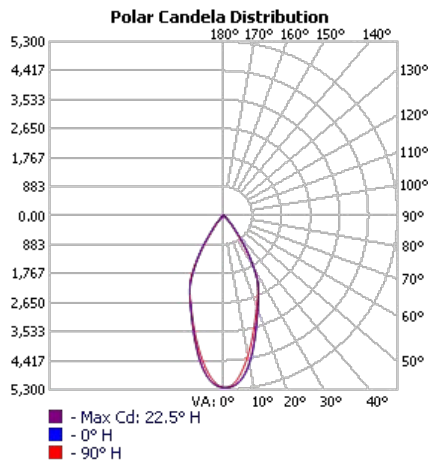
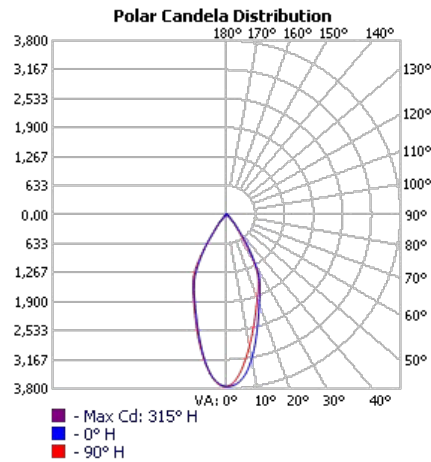
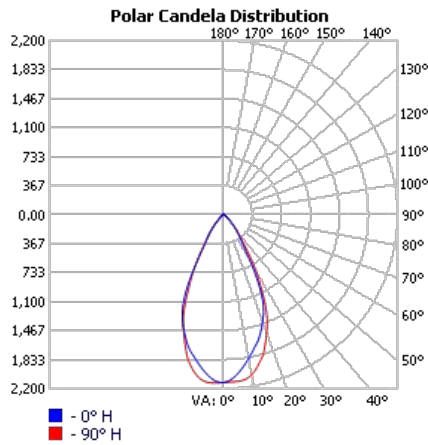

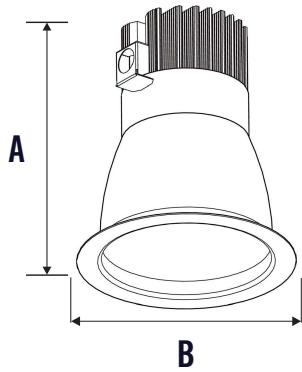

CDR / Reflector	A	B
CDR-6	8.64"	7.48"
CDR-7	8.95"	8.90"
CDR-8	9.76"	9.29"
CDR-10	10.50"	10.98"

**Recommend Dimmers for DC Models:**

**Leviton cat,Nos:**

AWRMG-7XX AWSMG-7XX  
 AWSMT-7XX IP710-LFZ/DLX  
[www.leviton.com](http://www.leviton.com)

**Lutron cat,Nos:**

DIVA-DVTV NOVA-NVTV NOVAT-NTFTV  
 W/PP20  
[www.lutron.com](http://www.lutron.com)

CDLH Dimensions

**New Construction Architectural Housing**

Heavy gauge die formed galvanized steel mounting frame. Attached to frame are vertically adjustable mounting brackets. Frames equipped with galvanized junction box UL Listed for through wire applications. Junction boxes equipped with (2) 3/4" and (4) 1/2" conduit knockouts with pryout slots and removable access doors.

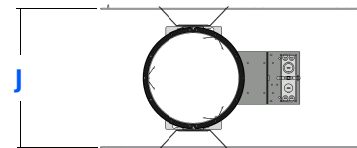
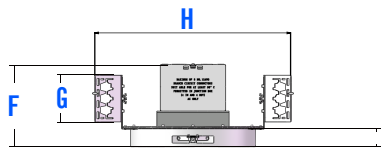
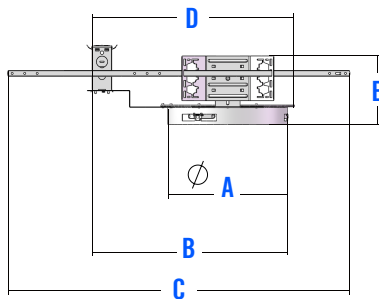
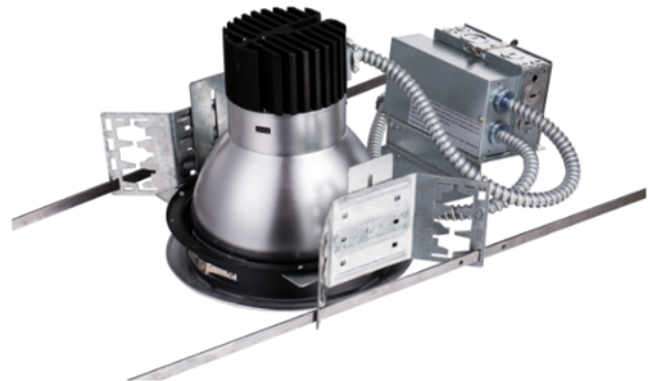

**Housing Dimensions**

	A	B	C	D	E	F	G	H	I	J
CDLH-6-N	6.37"	13.6"	27.2"	12.13"	5.42"	6.25"	3.54"	12.12"	1.33"	12.12"
CDLH-7-N	7.25"	13.6"	27.2"	12.13"	5.42"	6.25"	3.54"	12.12"	1.33"	13.05"
CDLH-8-N	7.71"	14.84"	27.2"	13.31"	5.42"	6.25"	3.54"	13.31"	1.33"	13.31"
CDLH-10-N	9.53"	16.12"	27.2"	16.12"	5.42"	6.25"	3.54"	14.99"	1.33"	14.62"